

LTD SERIES 1

ALL BEARING L TYPE DRILLS

ATTACHMENTS ONLY

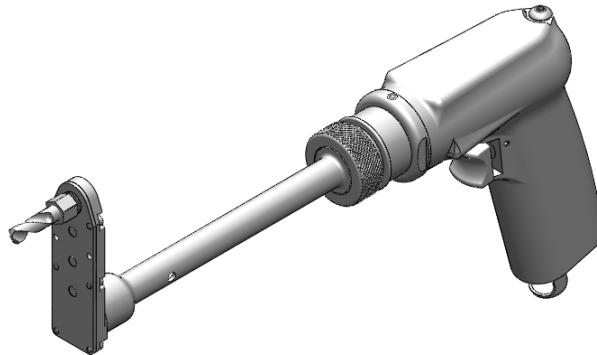

Shown with I7750
.85 HP 3000 RPM
offset motor

.250 inch
6.35 mm

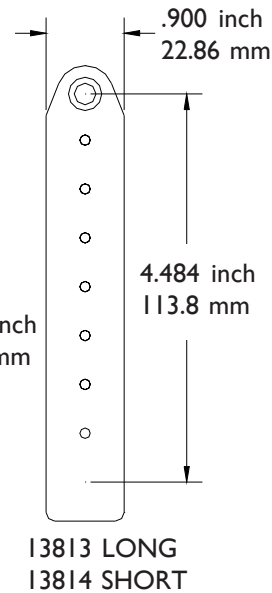
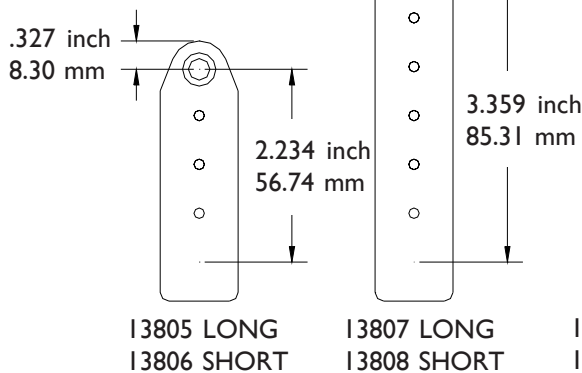
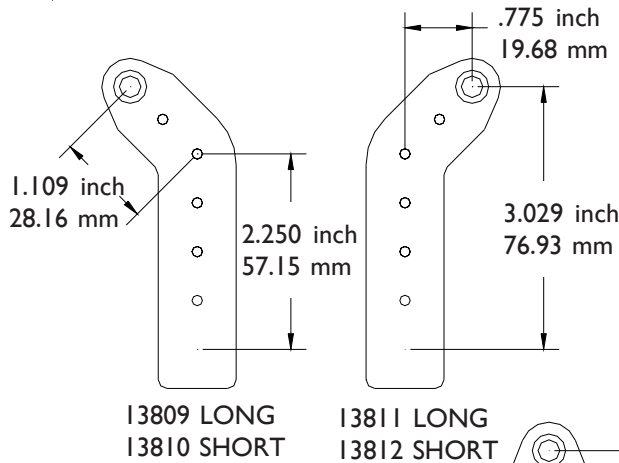
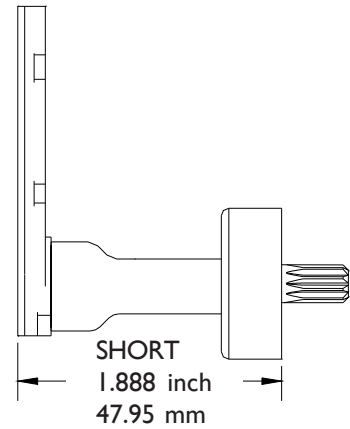
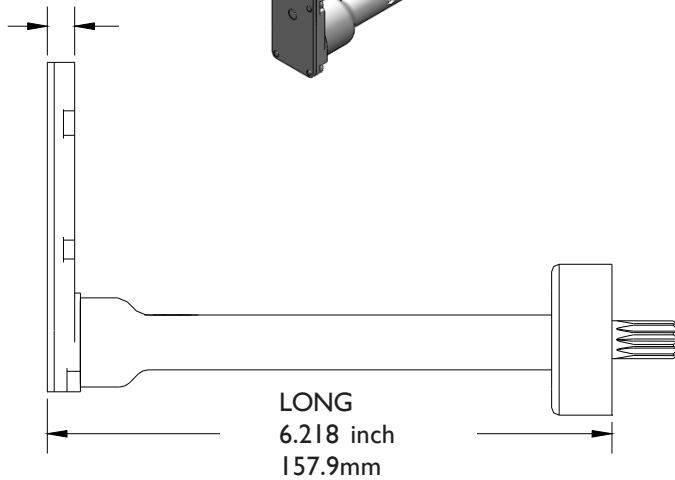

You must select an
internal thread

THREADED
DRILL



COLLET TYPE
DRILL



INTERNAL THREAD CODE	
1/4-28	A
10-32	C
9/32-40	E
5/16-24	F
7mm COLLET	D

PHONE: 775 883 1072 FAX: 775 883 4857